



## SPOT COOLER

with Heat Pump

# INSTRUCTION MANUAL

**SC-100** (110V/60Hz/1P)

**SC-150** (110V/60Hz/1P)

**SC-500** (220V/60Hz/1P)

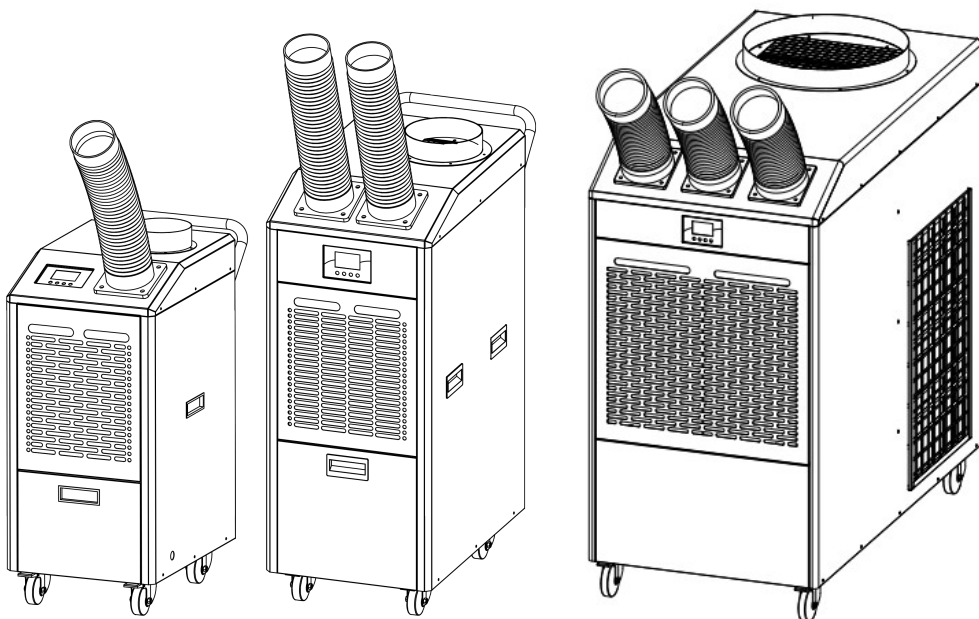

Please read this manual before operating the equipment. Keep it in an accessible location so it can be referred to whenever needed.

**Thank you for purchasing this product!**

**NOTE:**

Do not use the unit in places with gases or vapor containing hydrochloric acid, sulfuric acid, or any other corrosive substances.

# 1. Safety

Please do not operate the unit before carefully reading and understanding the content of this section. The items treated in this section are to ensure safe use of the unit and to prevent harm or injury to you and others. Further, to clarify the severity of the harm and injuries that can result from incorrect use, the items in this section are divided into two categories: Warnings and Caution. However, since the actions explained under caution also sometimes can cause severe harm, please follow all instructions in this section carefully regardless of category.

**Warning: Incorrect use can cause death or severe injury.**

**General caution**

 <b>Caution</b>	
<p>Do not use the unit in any other way than is described in this manual. **Incorrect use can cause electric shock, short circuit, water leakage and other accidents.</p>	<p>Take care for use on ships or in vehicles. **Use on ships or in vehicles can result in water leakage and a short circuit.</p>

**Carrying / Moving the unit**

 <b>Caution</b>	
<p>When carrying or moving the unit in any way, please keep it balanced and adapt your movement to the shape and weight of the unit at all time. **If the unit is dropped, there is a risk of injury and other accidents.</p>	<p>When packing the unit into and out of a vehicle, be sure to use two or more people to ensure safe operation. **If the unit is dropped, there is risk of physical injury and damage to the unit.</p>

## Testing and operating the unit

 <b>Warning</b>	
Do not put wet hands on the plug, the switch or the electric wires. **This can cause electric shock and injury.	Do not expose to water or oil. **Water or oil can cause a short circuit, electric shock and other accidents.
Earth the unit securely, and use an earth leakage breaker (bought separately) at all times. **If the unit is broken or has a short circuit, there is risk of electric shock.	Use a big enough electrical outlet. Do not plug in any other electrical appliance in the same outlet. **If other appliances are connected in the same outlet at the same time, the outlet can overheat and catch fire.

 <b>Warning</b>	
Please do not use the unit close to kerosene, gasoline, thinner, ether, paints or other flammable or explosive objects. **This can result in fire or explosion.	Do not use the unit close to dust, gas or steam containing aluminum, magnesium, titanium or other flammable substances. **This can result in fire or explosion.

 <b>Caution</b>	
If the unit is not working properly, pull the plug immediately and turn it in for service or repair. **There is risk of electric shock or fire caused by a short circuit.	Do not expose your body to the cold air from the unit for an extended period of time. **Prolonged exposure can harm your health. Use the swivel function, or direct the duct so it does not point directly at you.
Do not use the unit if vibrating or shaking or, on slanting surfaces. **The unit can unexpectedly move or fall, causing accidents and injuries. **Place the unit on a stable level surface.	Do not use the unit in places where it is exposed to water. **Contact with water can damage the insulation and cause electric shock, short circuit, fire and other accident and injuries.
Do not use in places with electrically conductive dust from Iron, carbon, casting, aluminum etc. **Electric shock or fire caused by a short circuit can occur.	If you use the unit in a very dusty environment, make sure to clean the interior of the unit regularly. **Electric shock or fire caused by a short circuit can occur.
Keep away from fire. **The unit can become deformed, causing short circuit and possibly fire.	Do not put hands or fingers into the exhaust hole. **There is risk of injury.
Do not use the unit if the cord or plug is damaged, or if the plug is loose in the socket. **Electric shock or fire caused by a short circuit can occur.	If you use an extension cord, make sure to use one that meets the specified requirements. **There is risk of the cord overheating and catching fire.

<p>Do not let the plug get dirty or get exposed to metal objects while plugged.</p> <p>**There is risk of electric shock, short circuit and fire.</p>	<p>Do not put heavy objects onto the electric cord.</p> <p>**If the cord gets damaged, there is risk of electric shock and fire.</p>
<p>Do not use the extension cord while it is coiled or bundled together.</p> <p>**There is risk of the cord overheating and catching fire.</p> <p>**Make sure that the extension cord is extended before use.</p>	<p>Do not use the unit in other than the stated operation conditions.</p> <p>**Since there is risk of electric shock, short circuit and malfunction, please use the unit within the suitable range.</p>
<p>Do not damage, process, nor bend, pull, twist or bundle the cord excessively.</p> <p>**If the cord gets damaged, there is risk of electric shock or fire.</p>	<p>Use where electrical supply is within the allowed range.</p> <p>**There is risk of electric shock and short circuit.</p>
<p>Remove the plug from the electric outlet when the unit is not in use.</p> <p>**There is risk of burning and other injuries, electric shock, fire caused by short circuit etc.</p>	<p>Do not use the unit in places with a lot of cutting oil or mineral oil.</p> <p>**They can cause the resin made parts of the unit to deteriorate, which can result in accidents and injuries.</p>
<p>When you unplug the plug, be sure not to pull it by the cord, but to pull it out holding the plug directly.</p> <p>**There is risk of electric shock, short circuit and fire.</p>	<p>Lock the caster wheels with the caster stoppers before starting to operate the unit.</p> <p>**The unit can start to move unexpectedly and cause accidents and injuries.</p>
<p>Do not use the unit in a place with dust that is harmful to the human body.</p> <p>**If harmful dust sticks to the unit, there is risk of harmful dust dispersal when the unit is in operation.</p>	



**Caution**

Make sure that the unit is unplugged when in storage.

\*\*There is risk of injury and electric shock.

**Maintenance**



**Caution**

Disassemble, repair and reassemble is not to be attempted by anyone other than an authorized repairman/ technician.

\*\*Inadequate or poor handling can result in fire, malfunction and injuries.

All maintenance must be conducted while the unit is unplugged.

\*\*There is risk of electric shock and physical injuries.



## 2. Product Specifications

Model number	SC-100	SC-150	SC-500
Voltage	Single phase 110V 60 Hz	Single phase 110V 60 Hz	Single phase 220V 60 Hz
Cooling capacity Heating Capacity	12000BTU/H(Cooling) 13200BTU/H(Heating)	16000BTU/H(Cooling) 18000BTU/H(Heating)	60000BTU/H(Cooling) 65000BTU/H(Heating)
Rated power	1000W	1700W	8500W
Air volume	500m <sup>3</sup> /h	700m <sup>3</sup> /h	3500m <sup>3</sup> /h
Rated running amps	9.0A	15.0A	39A
Noise	60-65dB	65-70dB	70-75dB
Dimension	15.5*20.5*34 in.	17.5*26.5*43.5 in.	30.5*55*58.2 in.
Outlet pipe (pcs)	1	2	3
Weight	55kg	82kg	280KG
Working temperature	32°F-113°F		
Refrigerant	R32		
Remarks	Above refrigerating capacity, power consumption, current operation on the basis of working temperature 95°F test values.		

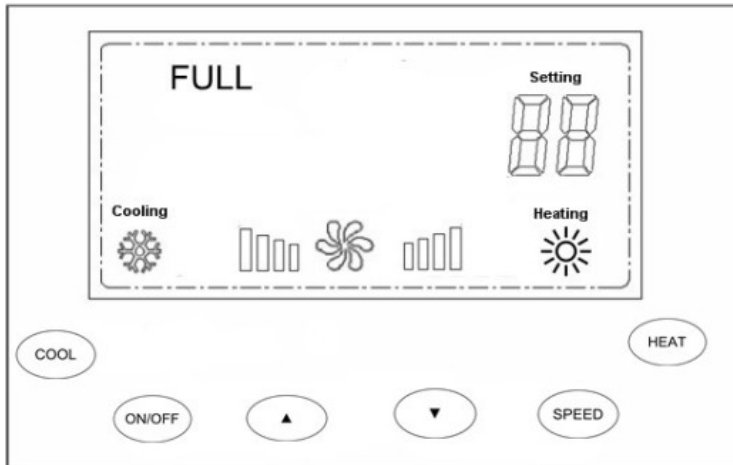

# 3. Operation

## Control Panel (SC-100 / SC-150)

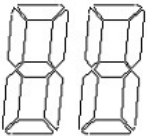







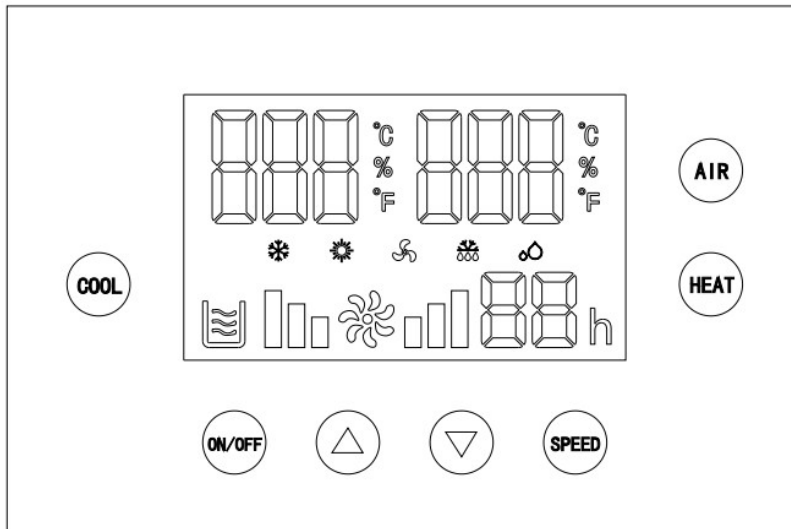

Display Icon	Description
Cooling Icon 	Press the cooling button and compressor will run. This icon will be shown. When the compressor stops it will flash. When turned off, it will not show the symbol.
Heating Icon 	Press the heating button and compressor will run. This icon will be shown. When compressor stops it will flash. When turned off, it will not show the symbol.
Fan Speed Icon 	<b>Switch On:</b> High fan displays fast, low fan displays slow. <b>Switch Off:</b> Fixed display.
Digital Icon 	<b>Normal situation:</b> Displays current room temperature. <b>Setting temperature:</b> Display flashing setting temperature value. <b>Water full:</b> Display "FU" <b>Failure:</b> Display failure codes every 30 second rotation.
Water Filled Icon <b>FULL</b>	<b>Normal situation:</b> Not displayed. This icon will flash when water tank is full (or water pump is defective). After emptying the water tank or repairing the water pump, this icon will disappear.

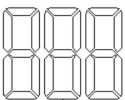
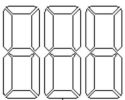
## Operating Instructions (SC-100 / SC-150)

Button	Description
<b>Single button operation:</b>	
<b>ON/OFF</b>	Turn on or turn off machine
<b>SPEED</b>	Adjust speed to high or low
<b>HEAT</b>	Press this button and the machine will go into heating function
<b>COOL</b>	Press this button and the machine will go into cooling function
	Increase temperature
	Decrease temperature
<b>Temperature Display Setting:</b>	
<b>▼ + SPEED</b>	Display current ambient temperature <i>(Press these 2 buttons for 3 seconds at the same time)</i>
<b>▲ + SPEED</b>	Display coil temperature <i>(Press these 2 buttons for 3 seconds at same time)</i>
<b>Water Pump Setting:</b>	
<b>▲ + ▼</b>	<p>Press and hold the two indicated buttons <b>together for 5 seconds</b>.</p> <p>Then press the ▼ button once:</p> <ul style="list-style-type: none"> <li>• If the display shows “<b>ON</b>”, the unit will <b>operate with the water tank</b> (internal water collection)</li> <li>• If the display shows “<b>OFF</b>”, the unit will <b>operate using continuous drainage</b> (via a hose or external water pump)</li> </ul> <p>Press the <b>SPEED</b> button to exit the setting mode.</p>

## Control Panel (SC-500)

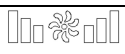

Display Icon	Description
Left icon 	Displays current temperature. When water tank is full, this icon will show "FU".
Right icon 	Displays set temperature. When setting temperature, it will be flashing.
	Unit is in cooling mode
	Unit is in heating mode
	Unit is in ventilation mode.
	Unit is in self-defrosting process.
	Water tank is full, or water pump is defective.
	Short bars: Low fan speed Long bars: High fan speed
	Timing ON/OFF hours From 00-24 H



## Operating Instructions (SC-500)

- **POWER** - Switch on/off machine.
- **COOL** - Press this button to go into cooling mode.
  - Then press arrow buttons to adjust temperature from 90°F-113°F.
- **HEAT** - Press this button to go into heating mode.
  - Then press arrow buttons to adjust temperature from 90°F-113°F.
- **AIR** - Press this button to go into air ventilation mode.
  - Compressor will not operate, only the fan will be running.
- **SPEED** - Adjust fan speed between low and high under any mode.
- **TO CONTROL WATER COLLECTION METHOD**
  - Hold both arrow buttons together for 6 seconds – display will show ON or OFF.
  - “ON” means unit is operating with water tank collection
  - “OFF” means unit is draining automatically

### TIMER OPERATION

#### WHEN UNIT IS ALREADY OPERATING:

Press and hold the SPEED button for 3 seconds to set the “timer off” hours. The timer icon will begin flashing. Use the ▲ (Increase) and ▼ (Decrease) buttons to adjust the timer from 0 to 24 hours. The unit will turn off after the specified amount of hours.

#### WHEN UNIT IS NOT YET OPERATING:

Press and hold the SPEED button for 3 seconds to set the “timer on” hours. The timer icon will begin flashing. Use the ▲ (Increase) and ▼ (Decrease) buttons to adjust the timer from 0 to 24 hours. The unit will turn on after the specified amount of hours.

#### **Power-off memory function:**

The machine will remember the settings before the power failure, when power is restored, the machine will automatically start and work based on the settings before the power failure.

#### **Compressor 3 minute delay protection:**

When restarting the cooling/heating mode, compressor needs to wait 3 minutes to restart working.

#### **Compressor overheat protection:**

When ambient temperature is more than 122°F, the compressor may go into overheat protection process, and will stop working automatically.

## Fault code table

<b>Fault code</b>	<b>Fault reason</b>	<b>Related content</b>
<b>E1</b>	Ambient temperature sensor failure	Checking sensor wiring connection. Replace new ambient temperature sensor.
<b>E2</b>	Evaporator coil temperature sensor fault	Checking sensor wiring connection. Replace new coil temperature sensor.
<b>E3</b>	Condenser coil temperature sensor fault	Checking sensor wiring connection. Replace new coil temperature sensor
<b>E4</b>	High pressure fault	Please ask professionals to check refrigerant gas leakage or not. Check the system's high pressure switch wiring connection Replace the high pressure switch
<b>E5</b>	Low pressure fault	Please ask professionals to check refrigerant gas leakage or not. Check the system's low pressure switch wiring connection Replace the low pressure switch
<b>E8</b>	Ambient temperature too high	Please move the machine to low ambient temperature places.

# SC-100 ELECTRICAL DIAGRAM

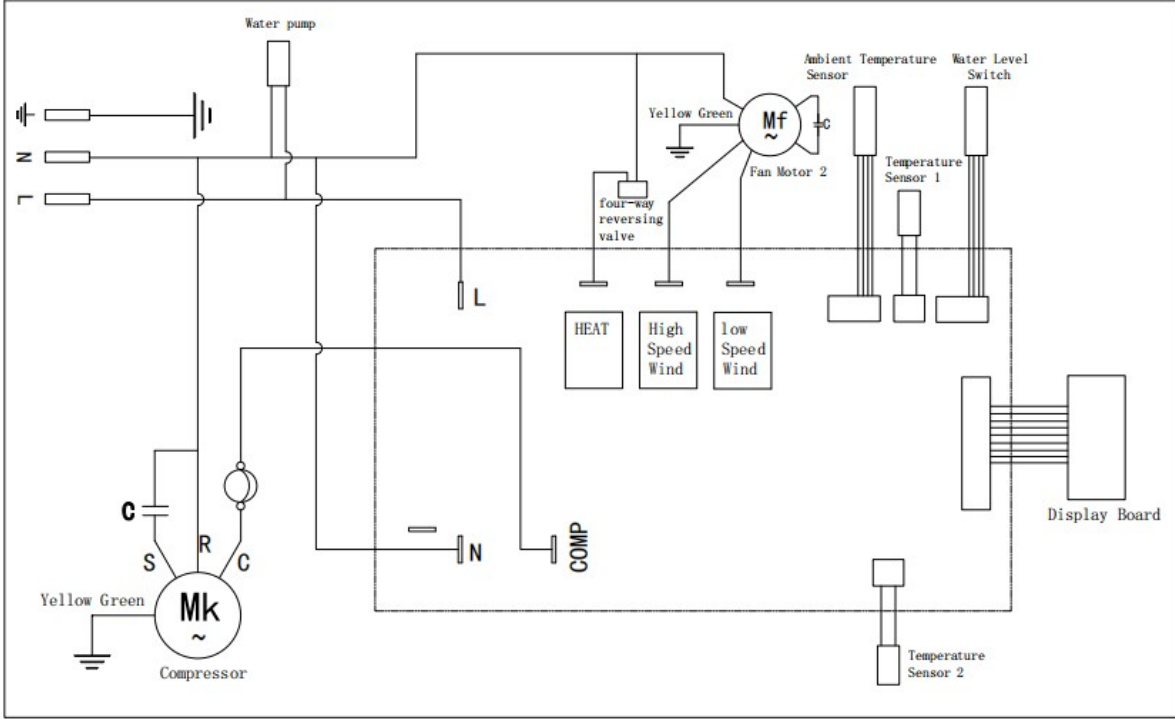

# SC-150 ELECTRICAL DIAGRAM

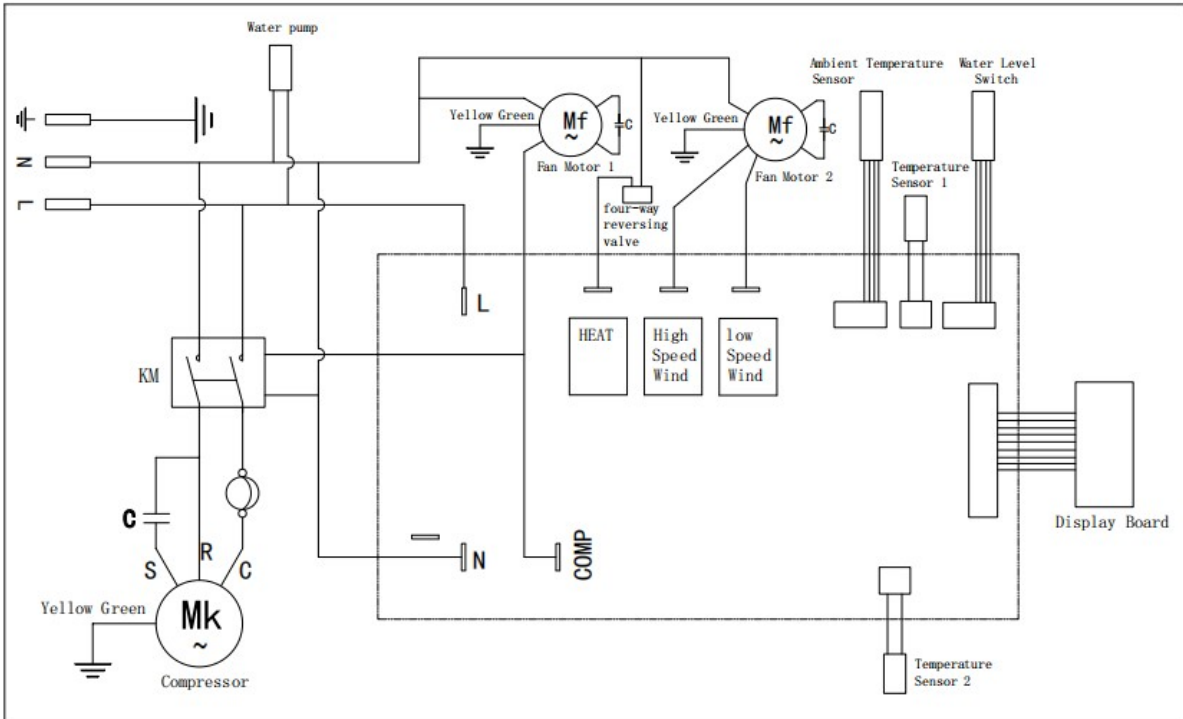

# SC-500 ELECTRICAL DIAGRAM

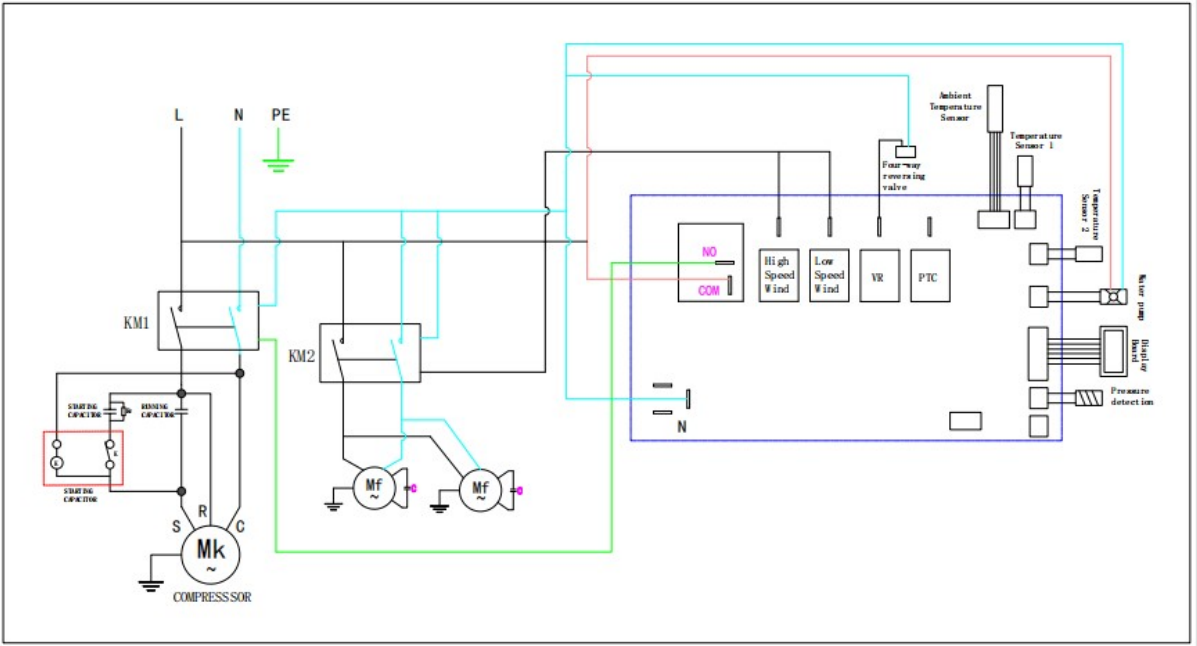

## 4. Setup

Important: To ensure safety, read section one "SAFETY" first.

### 1. Unit Placement

Ensure there is at least 12 inches of free space between all sides and any surrounding walls.

### 2. Connecting to a Power Source

Ensure no other electrical appliances are connected to the same power source / circuit.

Use a suitable plug and circuit breaker.

## 5. How to use

### 1. Adjusting the direction of airflow

The cool air duct can be adjusted, so please operate the unit after having pointed it in the desired direction.

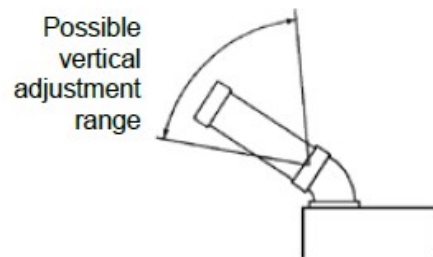
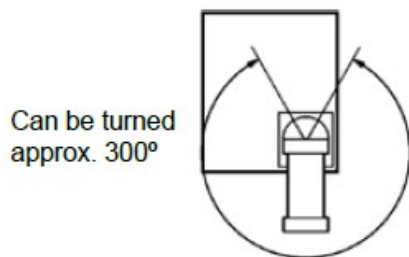

### Note

- ① Bend the cool air duct gently, firmly holding the duct elbow with your other hand.  
\*\* The duct can get damaged if forcedly bent too far.
- ② If something is dropped into the exhaust air vent, do not use a stick or similar object to try to retrieve it.  
\*\* You may damage internal parts and cause malfunction.
- ③ Where the duct's attachment peg and the air vent's attachment notch align, the unit comes off. Therefore use the cool air duct within the indicated range.

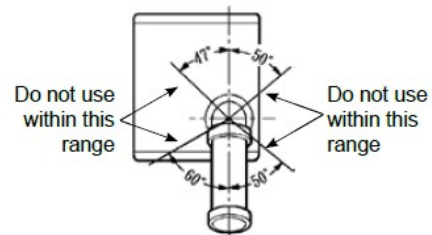

## 2. Drain Tank

### (1) The drain tank collects the condensed water

Part of the condensed water that appears in the upper cold part of the heat exchanger on the front of the unit vaporizes when it passes through the warm lower part on the way down to the drain tank. In certain environments almost all water will vaporize, leaving nothing for the drain tank. This does not mean that the unit is not working.

**Note:**

- ① The amount of condensed water that gathers in the drain tank varies depending on the temperature and humidity of the environment where the unit is used, as well as how clean or dirty the heat exchanger is. The amount of condensed water increases during rainy seasons and other times with high humidity, so be extra attentive at these times.
- ② When the drain tank becomes full the water will start spilling out on the floor, so check the amount of water in the drain tank frequently and empty it before it gets full.
- ③ Since the condensed water in the drain tank will spill when the unit is moved, be sure to empty the tank first.

### (2) Draining the condensed water with water pump.

**Please follow the below steps to install the water pump:**

- a. Please take out the original water tank.
- b. Fix the  $\Phi 14\text{mm}$  water hose to the water outlet of the water tray of the machine through a large clamp.
- c. Remove the dam-board above the water tank baffle plate.
- d. Knock down the side board hole, and install the through-plate joint. Please let  $\Phi 10\text{mm}$  length 1.5m water hose passes through the side board, also pass through the baffle plate, then fix one end of 10mm water hose to the outlet of the water pump with a small clamp.
- e. The water pump is fixed in the machine by 2 self-tapping screws. The original position of the water tank is provided with a reserved installation hole at the bottom. Horizontal move the water pump to ensure that the  $\Phi 14\text{mm}$  water hose can be inserted vertically into the water inlet of the pump.
- f. Please connect the pump power connector to the water tank baffle plate connector.
- g. Press these two buttons ▲+▼ at the same time for 5 seconds, then turn to button ▼, click once, it appears ON, the A/C will work with the water tank; click ▼ again, it appears OFF, the A/C will work with pipe draining or water pump.

## 6. Safety Devices

### The compressor overload relay

- ① The overload relay protects the compressor from over current's and overheating motor winding.
- ② The compressor overload relay is automatic. If the overload relay starts to work frequently (and the unit stops working), please take steps to eliminate the cause of the problem. If the cause is left unfixed, the unit can break down or malfunction.

Please consult "Troubleshooting" for more information.

## 7. Maintenance and Storage

### 1. Cleaning the filter

- ① Remove the filter by pulling it straight up.
- ② Clean off the dust from the filter with a vacuum cleaner.
- ③ If the filter is dirty, it should be cleaned with water.
- ④ Reinstall the filter into the unit after it has dried completely.

### 2. External maintenance

Wipe the ducts and other external parts clean with a dry piece of cloth, or a cloth with diluted neutral detergent.

**Note:** Be very careful if you use thinner, benzene, chemicals or polishing powder or similar substances when cleaning the unit. You can easily damage the coating or cause malfunction.

### 3. Before storing the unit

- ① Clean the filter and the exterior of the unit.
- ② Empty the drain tank and let it dry completely.
- ③ Turn on "Ventilation" for approximately one hour to let the internal parts dry completely.
- ④ Cover the unit with a suitable cover to prevent dust from gathering.
- ⑤ Store all the parts in a secure place so that nothing gets lost or damaged.
- ⑥ Clean the electric cord before storing it.

\* Regarding cleaning of the heat exchanger, the sirocco fan and other internal parts, please consult with your local dealer. If you clean the internal parts before storage, the unit can be used immediately afterwards.

## Note:

Store the unit in a vertical standing position. Do not store it lying down.

\*\* If the unit is stored lying down, the compressor or other parts can break down or malfunction.

## 8. Safety Inspections

To ensure safe operation, please perform the following inspections before use. If any fault or malfunction is discovered, please take measures immediately.

Inspection	Measure
Is the electric cord damaged or deformed?	Change the cord after having consulted with an authorized electrician.
Is the plug deformed or broken?	Change the plug after having consulted with an authorized electrician.
Is the cord and the power source connected correctly?	If not, connect them correctly.
Are the ducts deformed or torn?	Change them for new ones.
Is the filter clogged with dust or dirt?	Clean the filter.
Is the filter installed correctly?	If not, install it correctly.
Is the filter torn or damaged?	Change it for a new one?
Are the fin of the heat exchanger broken?	Hand the unit in for inspection and repair at your local retailer.
Is the heat exchanger fin covered with dust or greasy dirt?	
Is the filter or cool air duct blocked?	Remove the obstructing object.
Is the drain tank installed correctly?	If not, Install it correctly.
Is the drain tank damaged?	Change it for a new drain tank.
Are the caster wheels worn out?	Change the caster wheels.
Are the caster stoppers working normally?	If not, change the caster wheels.
Are all the switches and buttons working properly?	If not, consult page 13 of this manual and follow the instructions. If the problem remains even after that, please consult with your local dealer regarding inspection and repair.
Is the unit emitting strange sounds or smells?	Please consult with your local dealer regarding inspection and repair.



## 9. Troubleshooting

Problem	Check	Solution
Unit does not turn on	Is there power supply? (The power could be off because of blackout etc.)	Turn the power switch to "STOP" until the power is back on again. If the switch is turned to "COOL" when the power comes back on, the fuse might blow.
	Is the plug correctly connected in the outlet?	Insert the plug correctly into the outlet.
	Is the electric cord broken or damaged in any other way?	Fix the cord if possible, otherwise change it for a new one.
	Is the electric fuse blown or the breaker down?	Please consult with an electrician.
	Is the overload relay running?	The unit will restore itself automatically. Wait for the unit to be restored, turn the switch to "STOP", wait 3 minutes and then restart the unit.
The fuse blew or the breaker is down	Is the capacity of the breaker sufficient?	Make sure that no other appliance is connected to the breaker or the branch circuit.
	Did you keep the air conditioner turned off for three minutes?	If you have turned off the unit, make sure to wait at least 3 minutes before turning on the "COOL"/"HEAT" again. (This does not apply to "AIR", which can be turned on immediately.)
	Is the voltage too low?	Consult with your electric company.
The unit turns itself on and off frequently (The overload relay)	Is the voltage too low?	Consult with your electric company.
The air from the unit is not cool/heat	Is the power switch not set to "COOL"/"HEAT"?	Set the switch to "COOL"/"HEAT".
	Is the filter or cold air duct blocked?	Remove the obstructing object.
	If the filter clogged with dust or dirt?	Clean the filter.
The cooling/heating effect is weak	Is the room temperature too high/too low? (Higher than 113°F is too high/lower than 32°F)	Improve the ventilation to lower the temperature of the room, or use the unit in a room that correspond to required conditions: 77°F- 113°F(for cooling)/ above 32°F(for heating).
Water is leaking from the unit	Is the drain tank damaged?	Repair it or change it for a new one.
	Is the drain pipe clogged?	Clean the drain pipe.
	Is the drain tank full?	Empty the drain tank.
	Is the drain tank placed correctly?	If not, place it in its correct position.

## 10. After Service

### Caution

Please use manufacturer's parts for maintenance and repair.

\*\*If you use spare parts other than manufacturer's parts, there is risk that they will not fit properly and can cause malfunction or accidents.

### ● Repair

For questions regarding acquiring spare parts or regarding repair, please contact the store where you purchased the unit, after having prepared the product number, the manufacturer's serial number and the date of purchase.

### For your safety

\*\*If you intend to use the unit to preserve food products, animals and plants, precision machines, art objects etc., please check the specific requirements of those objects carefully before you commence. Inaccurate or inappropriate use can cause the quality of the objects to deteriorate.

\*\*Sometimes it will be necessary to perform installation work and electric work to the unit. In these cases, contact your local dealer or an experienced professional. If the works are performed inadequately, there is risk of electric shock, fire or accidents.